



GIN

EN

Yeti UL

RESCUE PARACHUTE MANUAL

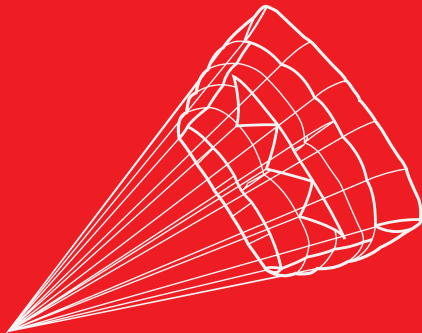

Please read this manual prior to installing the GIN rescue parachute into your harness

v.3.0 02/2026

Thank for choosing Gin Gliders. We are confident you'll enjoy many rewarding experiences in the air with your GIN rescue.

This manual contains important safety, performance and maintenance information. Read it before your first flight, keep it for reference, and please pass it on to the new owner if you ever re-sell your rescue.

Any updates to this manual, or relevant safety information, will be published on our website: **www.gingliders.com**. you can also register for e-mail updates via our website.

Happy flying and safe landings

GIN team

SAFETY NOTICE

Like any extreme sport, paragliding involves unpredictable risks which may lead to injury or death. By choosing to fly, you assume the sole responsibility for those risks. You can minimize the risks by having the appropriate attitude, training and experience and by properly understanding, using and maintaining your equipment. Always seek to expand your knowledge and to develop self-reliance. If there is anything you do not understand, consult with your local dealer as a first point of contact, with the GIN importer in your country or with Gin Gliders directly.

Because it is impossible to anticipate every situation or condition that can occur while paragliding, this manual makes no representation about the safe use of the paragliding equipment under all conditions. Neither Gin Gliders nor the seller of GIN equipment can guarantee, or be held responsible for, the safety of yourself or anyone else.

Many countries have specific regulations or laws regarding paragliding activity. It's your responsibility to know and observe the regulations of the region where you fly.

PURPOSE

The Yeti UL was developed to be used as a manually released parachute for paraglider pilots in an emergency situation while flying.

CONDITIONS OF USE

Maximum speed for usage: 32 m/s (115 km/h)

Repacking interval: 12 months, the rescue parachute should be repacked and recorded in the “Re-packing History” section of this book.

Inspection interval: 12 months, each time the rescue is repacked it should be inspected for damage, the effect of water, sand, salt or other environmental influences may reduce the repack / inspection interval.

Replace: 10 years, it is recommended that the rescue be replaced even if never used.

Model (Type)	Yeti UL (Single seat, Not Steerable)		
Size	S	M	L
Area (m ²)	19.0	23.0	27.0
Line length (m)	4.49	4.92	5.39
Center line (m)	4.27	4.67	5.12
Weight (kg)	0.87	0.99	1.17
Sink Rate (m/sec.)	5.3	5.2	5.1
A number of riser	1	1	1
Volume (cm ³)	2025	2475	3006
Min/Max load (kg)	55 / 85	65 / 100	75 / 120

The Yeti UL is certified in accordance to the EN 12491:2015 standard.

GIN rescue parachutes are inspected and packed at the factory. It is recommended that the reserve is repacked by a suitably qualified and experienced paragliding professional or parachute rigger prior to installation into your harness. The efficacy of the rescue, and your life, depend on the correct packing procedure. If in any doubt whatsoever, please seek professional advice from your instructor, GIN dealer or importer.

AIRING

Before packing, the canopy should be aired. Ideally, the canopy should be hung by its apex from the ceiling for between 6 and 24 hours in a cool, dry room.

PREPARATION

The packing area must be spacious, clean, smooth and dry.

PRELIMINARY MATERIALS

Before starting the packing procedure, make sure you have the following materials:

- 2 solid weights or sandbags, which should be smooth and clean (2-2.5kg)
- Elastic bands

LAYOUT

Check the serial number that is written on the top center panel and on the re-packing card first (re-packing card is attached at the end of this manual). Fix the risers to a solid point using carabiners.

SPARE PARTS

Elastic band will be supplied in the plastic bag for the re packing.

LINE CHECK

- 1) Stretch the rescue out to its full length.
- 2) Anchor the riser connection to keep lines tight.
- 3) Check the suspension lines for tangles by the “4 lines check” method:
 - All lines should be located inside the first 2 and last 2 lines as illustrated.

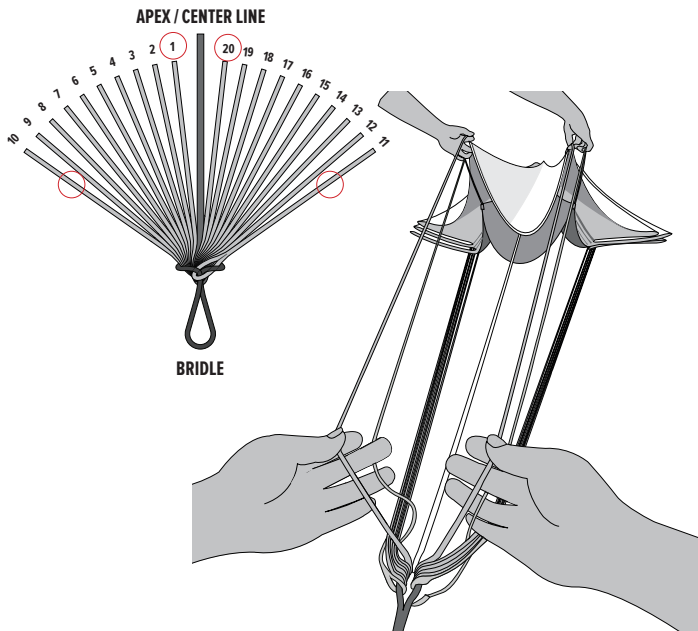

FOLDING THE PANELS

- 1) Separate lines as shown:
 - Make sure 1 is on TOP, 11 is on BOTTOM and the Center Line MIDDLE
- 2) Fold in half with all of the panels to the LEFT

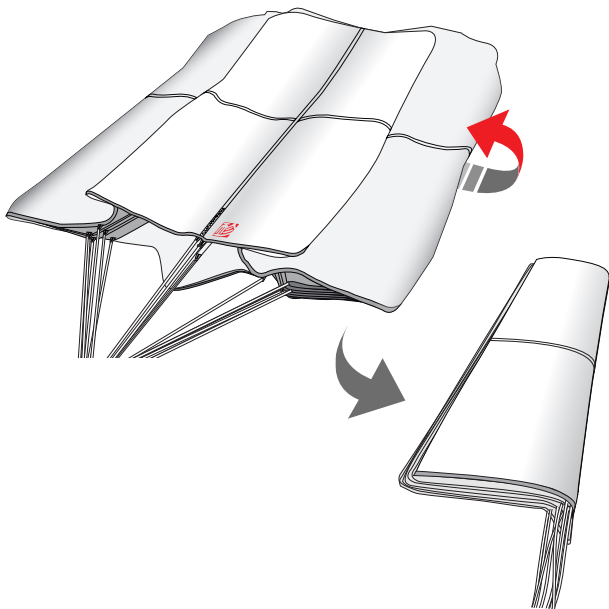

NOTE: Use the Gin Stamp as a reference point.

DIVIDING THE PANELS

Begin to fold all of the panels to the RIGHT.
There are 2 corner sections on each side
that should be folded as shown below:

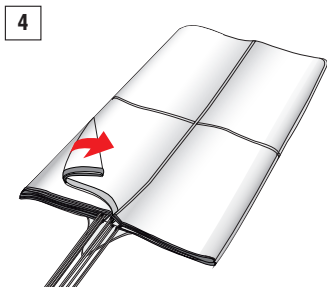
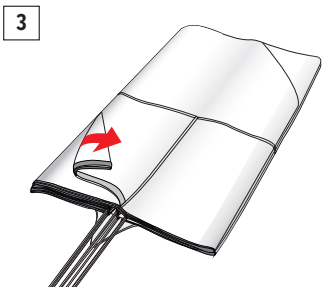
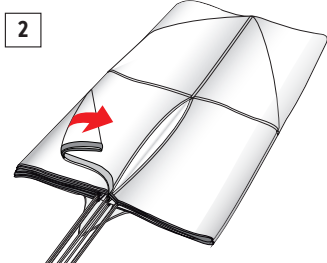
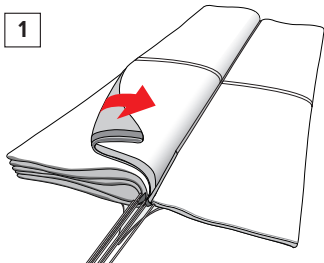
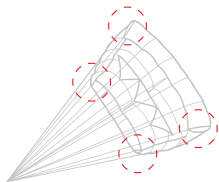

IMPORTANT: The 2 corner sections on each side should be folded as shown.

Once you reach the TOP panel, place weights on the RIGHT side to keep the folds clean. Fold the rescue in half again, this time onto the RIGHT side. Repeat steps 1-4 for the LEFT panels.

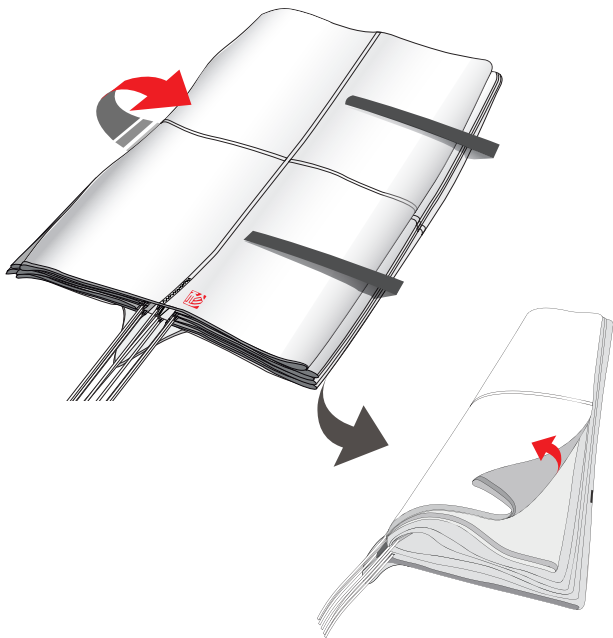

IMPORTANT: Make sure that all the skirts are even and all the lines are tight together.

After you have neatly folded both sides of the rescue, check that the panels are clean and the lines are free of tangles

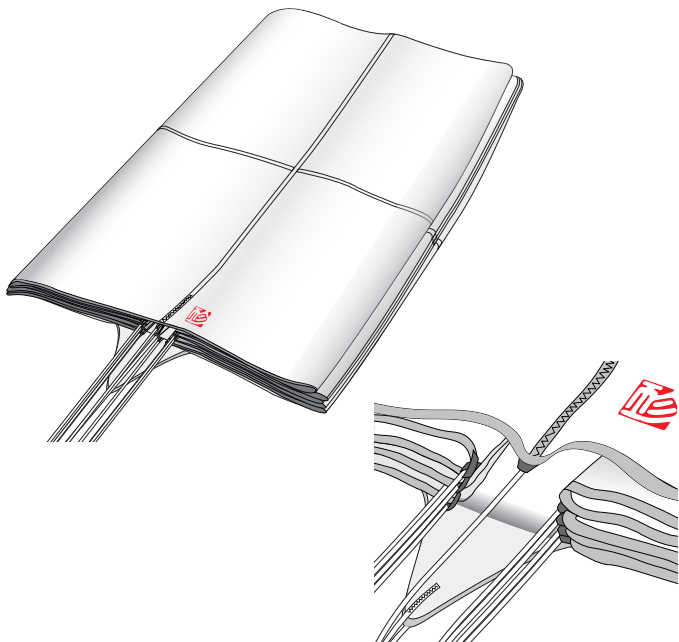

IMPORTANT: After folding all the panels, check again that the center seams and the inside of the panels are even and lie in the same direction.

INNER BAG FOLDING

- 1) Fold the corner only half way to the center line as shown (45°).
- 2) Next fold the rescue into 1/4 by folding the left and right edge in to the mid-line. Fold the lines as shown.

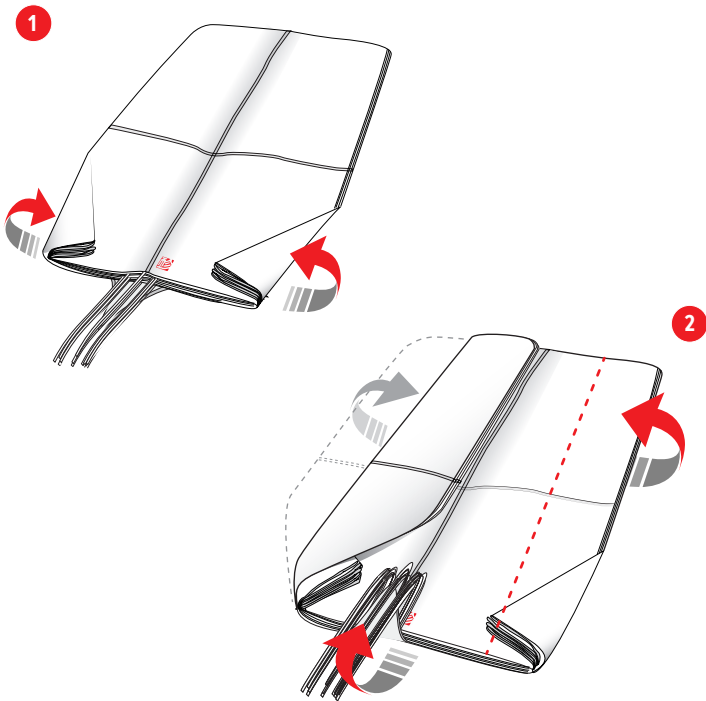

3) Fold the rescue in half.

4) Carefully fold the rescue onto itself as shown.

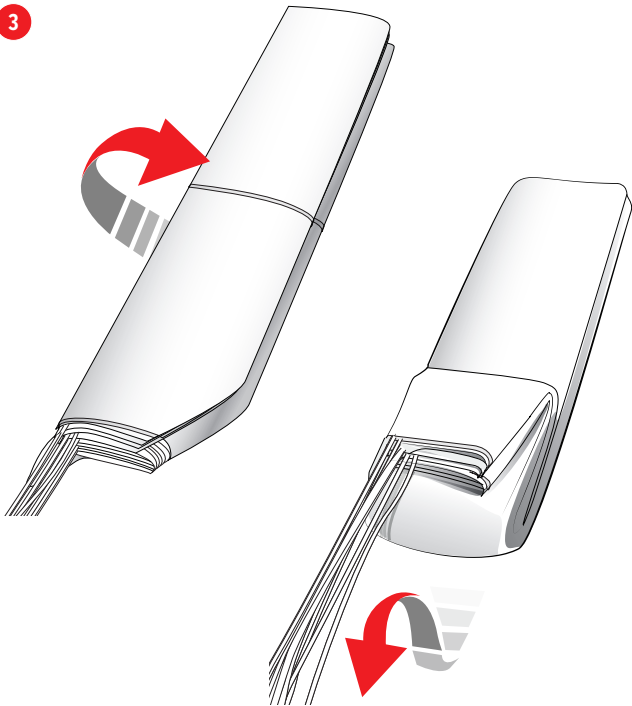

5



Fold the rescue over the top of the suspension lines.

6

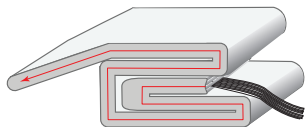

Fold the top to make clean.

7

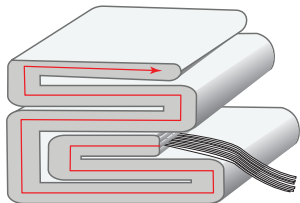

Fold the rescue so that the suspension lines are in the middle, be sure to follow this pattern.

PACKING DEPLOYMENT BAG

Stow the canopy so that the skirt is on top of the folds in the inner bag.

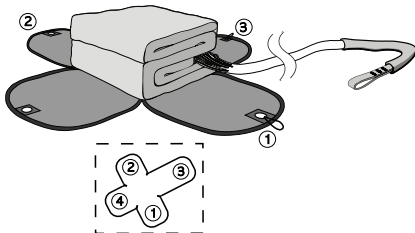

STOWING THE LINES

Start to stow the suspension lines making sure you keep the equal tension on all lines. Lay the upper suspension lines between the canopy and the inner bag, and close the two flaps, numbers 1 and 2, with a bight (3cm loop) of lines through the elastic closing loop.

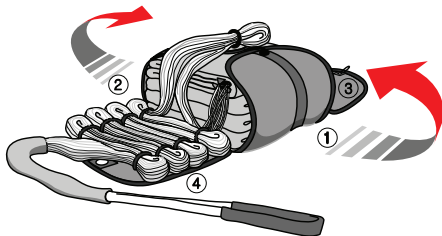

Stow the lower suspension lines in a 'figure of 8' pattern, fixing each pair with rubber bands at each end.

CLOSING THE DEPLOYMENT BAG

Thread the closing loop attached to the deployment bag through the eyelets of the last two flaps and place a bight (3cm loop) of suspension lines through the elastic closing loop. The last 30-50cm of the lines is left free.

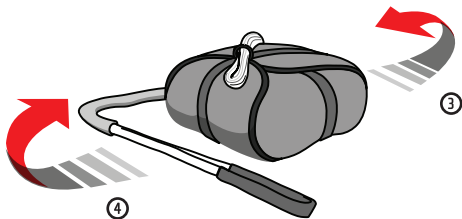

TEST

Lifting the bridle, check the force required to allow the lines to free themselves from the closing loop of the deployment bag. This force should be around 200g. This force may be verified with a spring balance, if available.

IMPORTANT: Suspension lines should always have equal tension!

DEPLOYMENT BAG WARNING

Yeti UL has been tested and found compliant using the original Gingliders inner container. (The speed of opening and opening shock test has been completed using the inner container supplied) Use of any other inner container may produce different results, including failures.

The Yeti UL is compatible with GIN harnesses. It may also be compatible with most other manufacturer's harnesses, but there is no guarantee of this and you should check with your instructor or dealer.

OUTER CONTAINER ATTACHMENT

The Yeti UL can be attached to harnesses which do not have a built-in rescue container, like the speed glider harnesses. Use of a rescue on these harnesses requires an outer container bag. You must follow the harness and outer container bag instructions for proper attachment. If in doubt, consult with a professional.

ATTACHING THE RESCUE BRIDLE TO THE HARNESS WEBBING

To connect the Yeti UL to your harness, there are three ways, GIN Rescue carabiner, Soft shackle and Direct loop. If you choose to use a different type of connector, it should be rated at least 9 times the maximum weight. For example, our recommended 6mm Stainless Steel screwgate maillon (square) connector has a minimum breaking load of 31kN (3163 Kgf). It is the pilot's responsibility to check the compatibility of the rescue system and ensure that it is installed properly.

Be sure to inspect your connector during normal maintenance and safety checks. Replace it whenever there are any signs of wear and check your rescue system with a professional after any deployment. We recommend that you cover the connection using the Maillon rapid cover to prevent excess friction. Rubber-bands should also be used to secure the attachment and prevent excess friction.

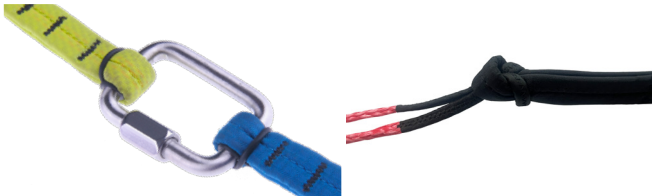

ATTACHING THE DEPLOYMENT HANDLE

Most harnesses come with their own deployment handle. This handle and its strap must be connected to the deployment bag of the parachute. In particular, check the length of the strap connecting the rescue deployment handle to the rescue inner container. It should be long enough that the reserve can be extracted without the danger of the pins not being pulled before the strap tightens on the reserve, but not so long that there is excessive slack that extends the movement required for deployment.

PREFLIGHT CHECKS

For maximum safety, use a complete and consistent system of preflight checks of your equipment and repeat the same mental sequence at every flight.

Specifically for the rescue, check that:

- There is no visible damage that could affect its airworthiness.
- The rescue parachute container is closed correctly with the pin(s) in place.
- The deployment handle is secured correctly and all parts are in good condition. If any part of the harness/reserve/handle system include Velcro, then this must be separated and re-attached regularly to prevent Velcro 'bedding in' over time which can make rescue deployment much more difficult.

RESCUE DEPLOYMENT

It is vital to periodically feel the position of the rescue handle in normal flight, so that the action of reaching for the rescue is instinctive in an emergency.

In the event of an emergency, the pilot must quickly evaluate his or her height and the seriousness of the incident. On that basis, an instantaneous decision to deploy the rescue or not must be taken. Deploying the rescue when the glider is recoverable may increase the danger of injury. If you have sufficient height and the glider is in a flat spin, it is preferable to first try to stop the spin (e.g. full stall), due to the risk of entanglement. On the other hand, a second's hesitation in deploying the reserve could prove costly if there is insufficient height.

Procedure

If the rescue is to be deployed, the procedure is as follows:

- ☑ Look for the rescue handle and grasp it firmly with one hand
- ☑ Pull firmly upwards/side wards on the handle. This action undoes the Velcro or handles closure and allows the release pins to be pulled out of the release loops, so that the inner container can be released from the harness' rescue compartment.
- ☑ Look for a clear area, and in a continuous motion, throw (and RELEASE!) the rescue as quickly and forcefully as possible away from yourself and the glider. Throwing the rescue in the direction of the air stream will speed opening, and throwing it against the direction of spin will help prevent tangling with the glider.
- ☑ After deployment, avoid entanglement and pendulum motions by pulling in the glider as symmetrically as possible with the B, C, D or brake lines
- ☑ On landing, be sure to do a PLF (Parachute Landing Fall) to minimize the risk of injury
- ☑ Once on the ground, deflate the canopy by pulling on the center line to avoid the possibility of being dragged.

The Gin rescue parachute should be repacked at least every 12 months, as detailed in the packing instructions. We always recommend that this rescue parachute is inspected and repacked by a trained professional repacker. Additional inspections should be performed if there is any suspicion of damage or undue wear.

After a deployment, the rescue should be checked by the distributor or manufacturer. Always seek professional advice whenever in doubt.

The materials used in the GIN rescue have been carefully selected for maximum durability. Nevertheless, maintaining your rescue following the guidelines below will extend its lifetime.

It is recommended that a rescue is replaced after 10 years, even if it has never been used.

STORAGE

Unnecessary exposure to UV rays, heat and humidity should always be avoided. Keep your harness and rescue in your rucksack when not in use. Store all your paragliding equipment in a cool, dry place, and away from solvents such as grease, acid, oil and paint.

Never put your rescue away while damp or wet.

If your rescue parachute does ever get wet (i.e. water landings or snow) you must remove it from the harness, dry it naturally in the air, and repack it before putting it back into the container.

A dirty rescue canopy or container can be cleaned with lukewarm water. Mild, neutral soap may be used if necessary, but do not rub the fabric. Rinse the canopy thoroughly and allow it to dry naturally. If the canopy shows signs of mildew or mold, it must be sent to the distributor or manufacturer for repairs, as the strength could be compromised.

If the rescue is to be stored for an extended period, the canopy should be opened and loosely rolled.

DAMAGED RESCUE

If there is any noticeable damage to the rescue parachute after inspection, the rescue must be sent for inspection/repair to the manufacturer.

GIN QUALITY AND SERVICE

We take pride in the quality of our products and are committed to putting right any problems affecting the safety or function of your equipment and which are attributable to manufacturing faults. Your GIN dealer is your first point of contact if you have any problems with your equipment.

If you are unable to contact your dealer or GIN importer, contact Gin Gliders directly via our website.

GIN LIFETIME GUARANTEE

Gin Gliders are proud to guarantee the quality, craftsmanship and performance of all our products. Equipment with defects in materials or manufacturing will be repaired or replaced at the discretion of Gin Gliders for the practical lifetime of the product. Equipment damaged through wear and tear, misuse or neglect may be repaired at a nominal charge.

If you have any problems with your equipment, please contact your GIN dealer in the first instance, or Gin Gliders directly via our website.

CARE OF THE ENVIRONMENT

We are privileged to fly in areas of outstanding natural beauty. Respect and preserve nature by minimizing your impact on the environment. When visiting an area, contact the local club for details of environmentally sensitive areas and local restrictions.

Gin Gliders gives consideration to the entire life cycle of its products, the last stage of which is recycling in an environmentally-friendly manner. The synthetic materials used must be disposed of properly. If you are not able to arrange appropriate disposal, Gin Gliders will be happy to recycle it for you.

Send the equipment with a short note to this effect to Gin Gliders Inc.

RE-PACKING HISTORY

Pilot name:

First installation date:

--	--

Serial No.

--

Repacking Date	By	Signature

Every effort has been made to ensure that the information in this manual is correct, but please remember that it has been produced for guidance only.

This owner's manual is subject to changes without prior notice. Please check **www.gingliders.com** for the latest information regarding the GIN rescue parachute and other GIN products.

Product registration

Register your product for full warranty benefits:
www.gingliders.com/register



Gin Gliders Inc.

2318-32, Baegok-daero, Mohyeon-myeon,
Cheoin-gu, Yongin-si, Gyeonggi-do, Korea 17036
www.gingliders.com